

Article number: 201580M616MT

Description: E+G Screw GN 1580-M6-16-MT-H
Hygienic design

Measures

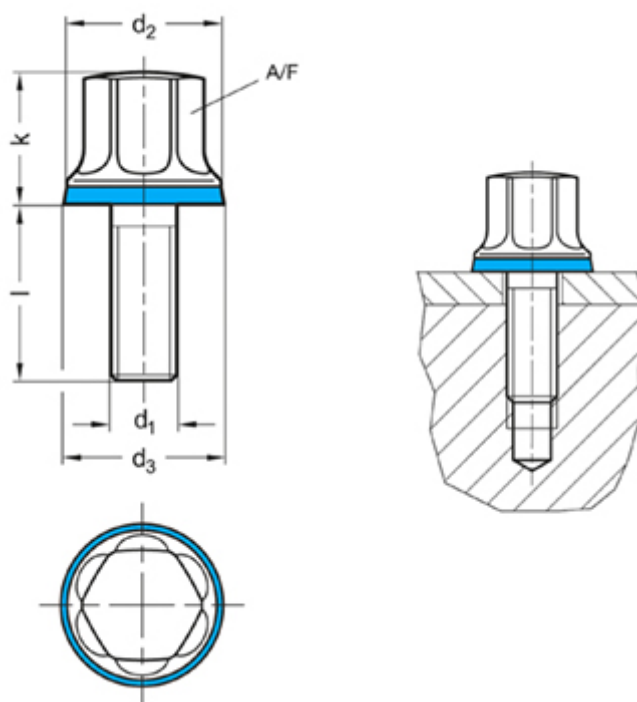

d1	= M 6
d2	= 14
d3	= 14.8
k	= 12
L	= 16
t min	= -
Weight in (g)	= 12